

YAMAHA Hi-Fi STEREO

PARTS LIST

NS-1000 SERIES

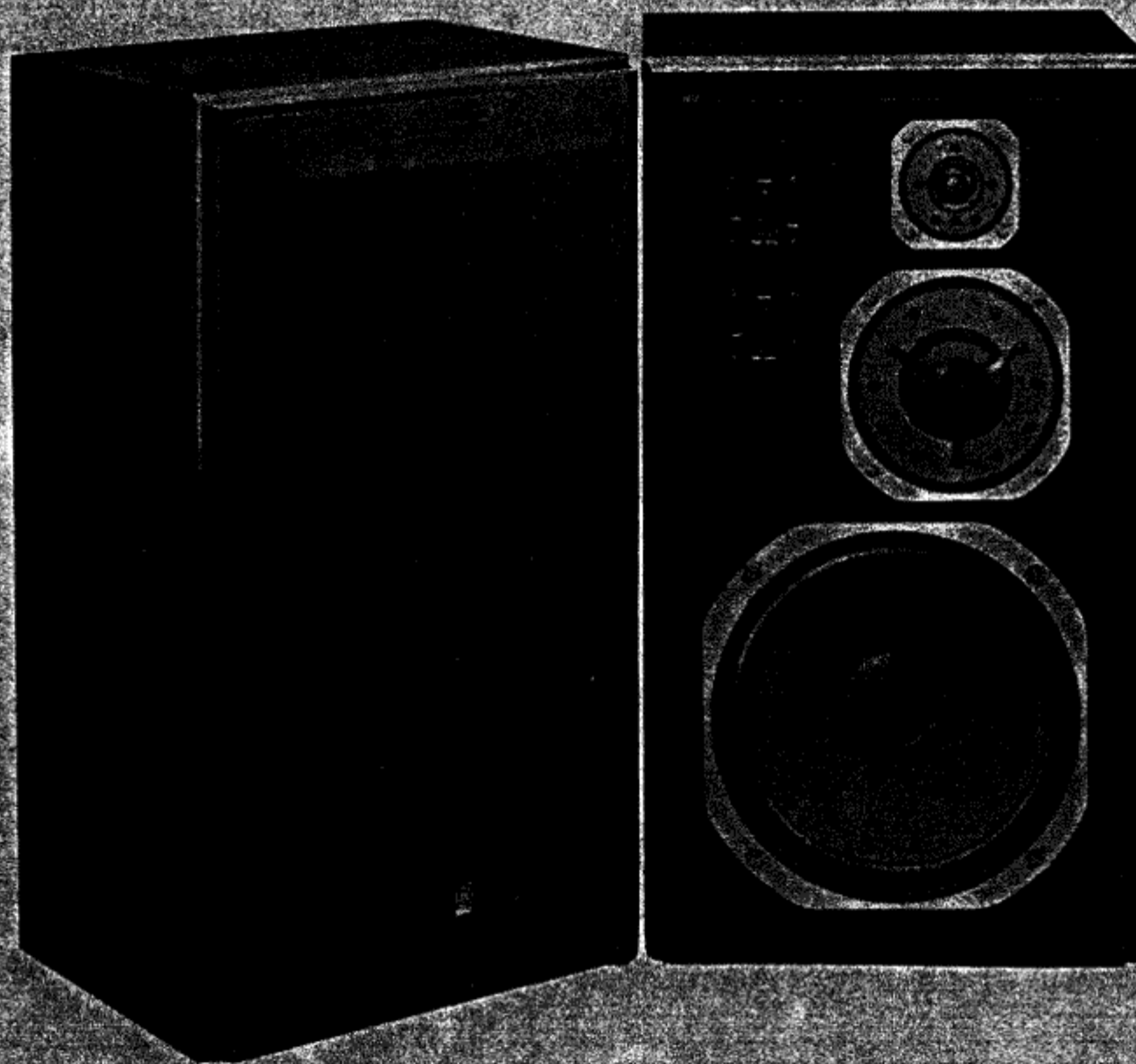

 **YAMAHA**

APL-40

① ⑤ Printed in Japan

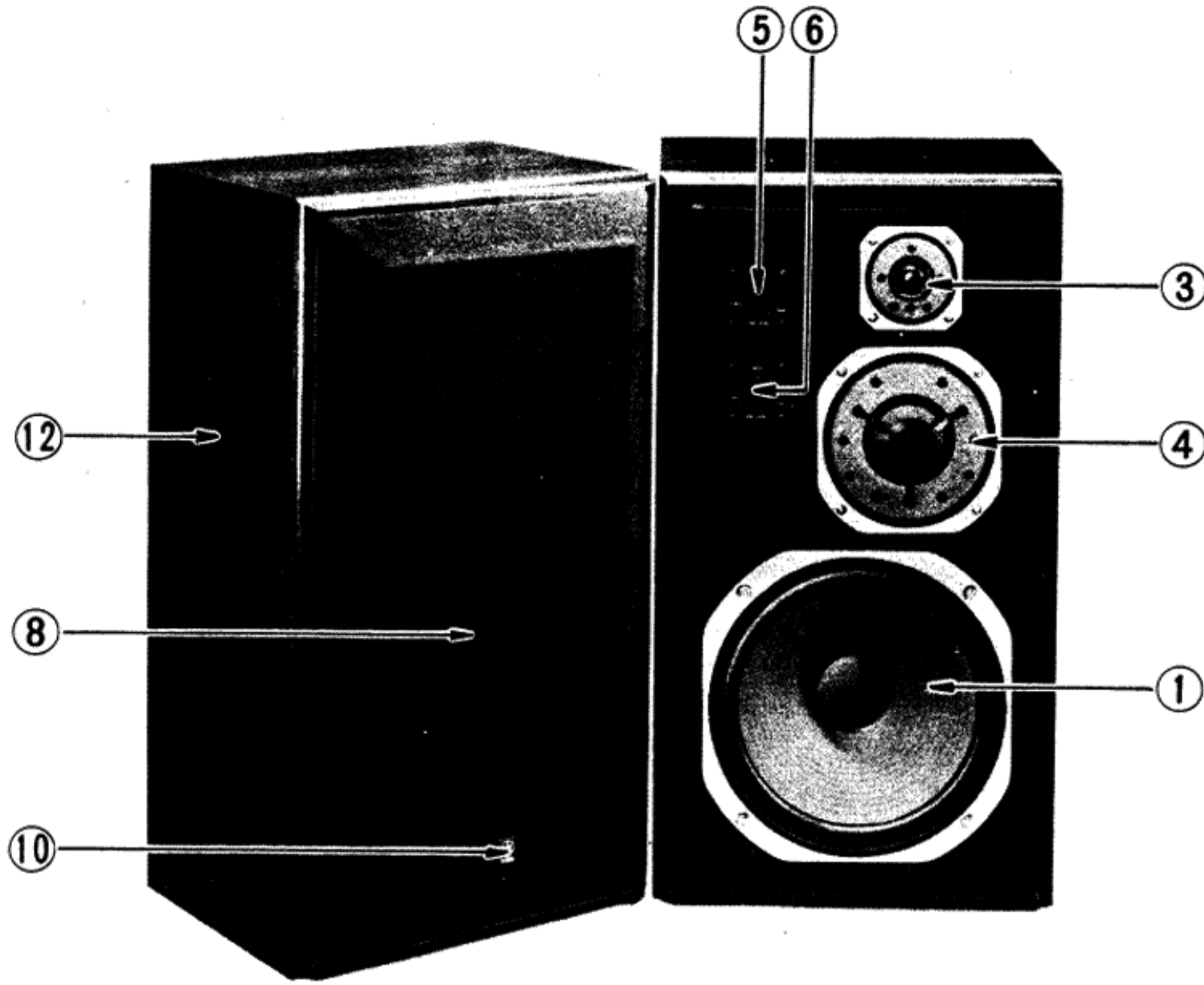

NS-1000

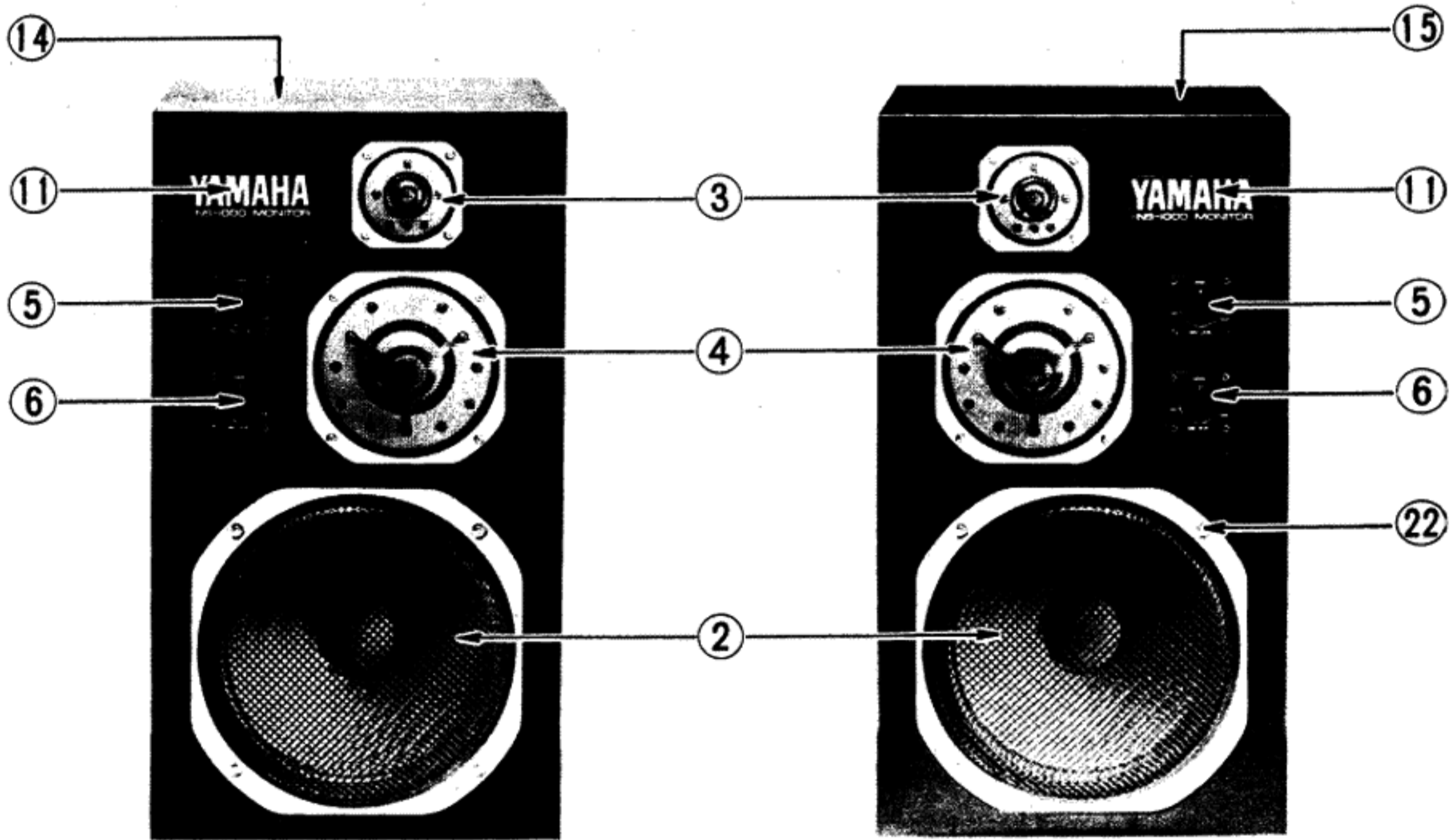

NS-1000M

NS-1000 SERIES

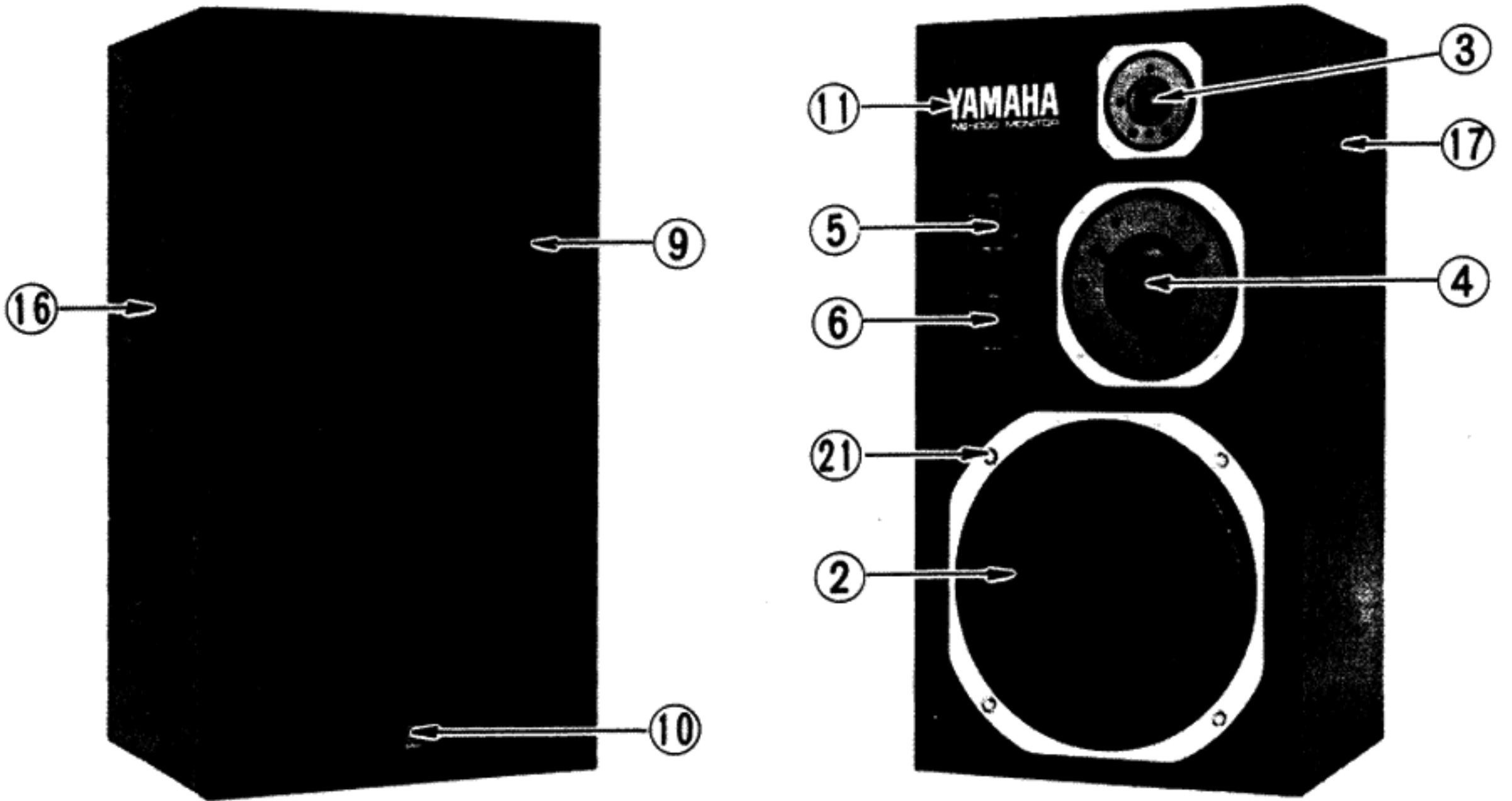

NS-1000MS

NET-WORK ASSEMBLY

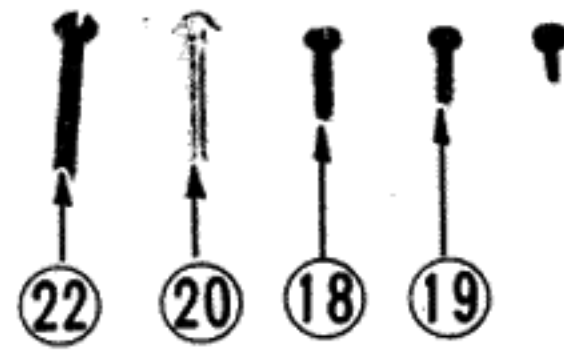
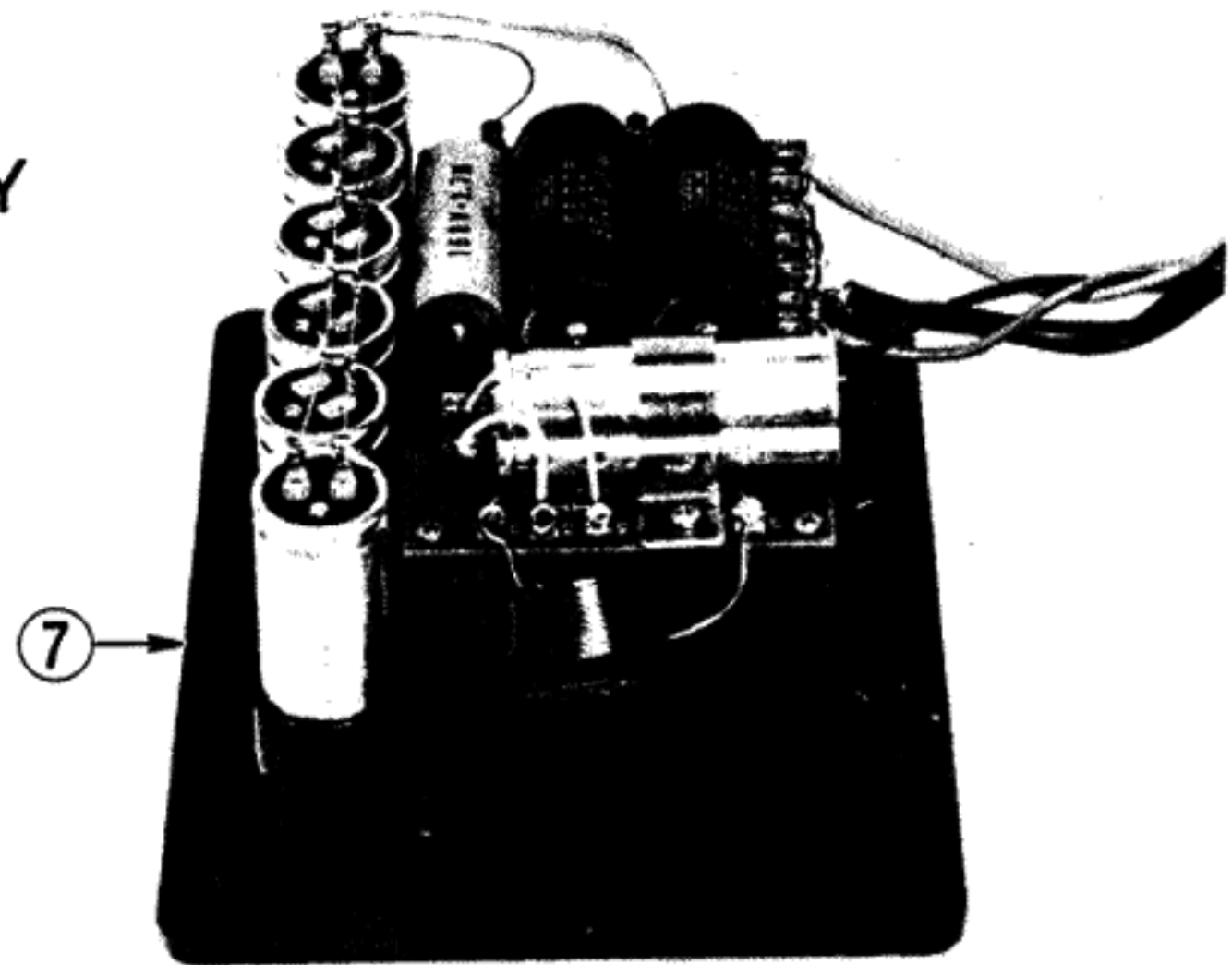

Schematic Diagram

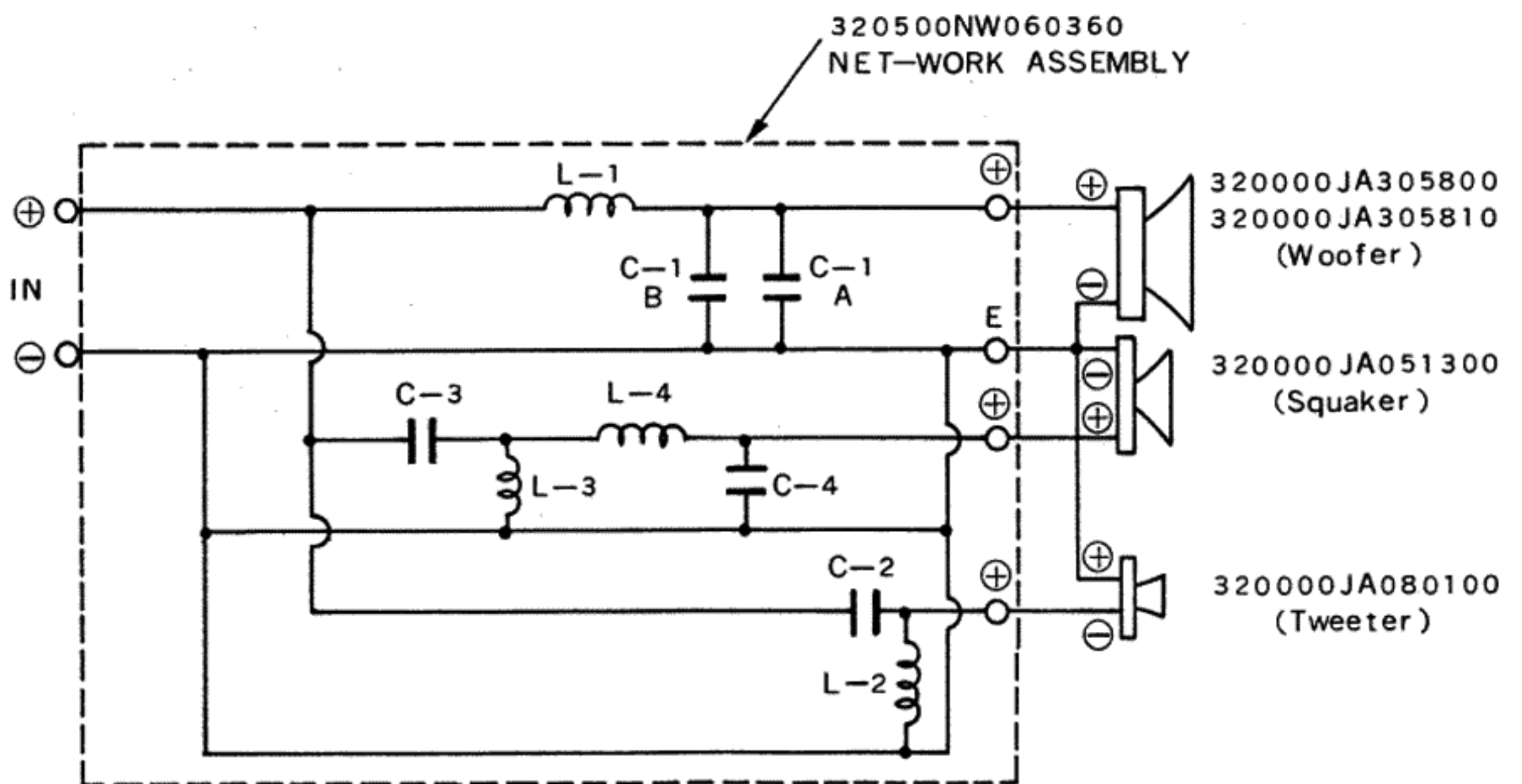

NS-1000 SERIES

| Ref. No. | Part No. | Description | | Remarks | Common Models | FOB Japan US \$ |
|----------|----------------|--------------------------------------|----------------------|--------------------------------------|---------------|-----------------|
| ① | 320000JA305800 | Speaker (Woofers) | スピーカ ウーハー | NS-1000 | | |
| ② | 320000JA305810 | -do.- (Woofers) | スピーカ ウーハー | NS-1000M, 1000MS | | |
| ③ | 320000JA080100 | -do.- (Tweeter) | スピーカ ツイーター | NS-1000, 1000M, 1000MS | | |
| ④ | 320000JA051300 | -do.- (Squaker) | スピーカ スクォーカー | -do.- | | |
| ⑤ | 320575NB071950 | Level Control Assembly (High) | レベルコントロール アッセンブリー | -do.- | | |
| ⑥ | 320575NW071960 | -do.- (Middle) | " | -do.- | | |
| ⑦ | 320500NW060360 | Net - Work Assembly | ネットワーク アッセンブリー | -do.- | | |
| ⑧ | 32057600031000 | Front Panel | 前板サラン張り | NS-1000 | | |
| ⑨ | 32057500031000 | -do.- | " | NS-1000MS | | |
| | 320000CB074910 | Ratch | ラ ッ チ | NS-1000MS | | |
| ⑩ | 320000BA066960 | Audio-Emblem | オーディオ エンブレム | NS-1000, 1000MS | | |
| | 420000CB069610 | Strike | ストライク | NS-1000MS | | |
| | 420000CB069620 | Support | サポ ー ト | -do.- | | |
| ⑪ | 420000CB072770 | Lavel | ラ ベ ル | NS-1000M, 1000MS | | |
| | 420000LA000860 | Push Terminal 2PD | 2PD型 プッシュターミナル | NS-1000, 1000M, 1000MS | | |
| | 320500MZ064420 | Speaker cord | S P コ ー ド | NS-1000, 1000M, 1000MS | | |
| ⑫ | 32057685040001 | Wooden Cabinet ,Left | 外 装 | NS-1000 | | |
| ⑬ | 32057685040000 | " ,Right | " | -do.- | | |
| ⑭ | 32057508040001 | " ,Left | " | NS-1000M | | |
| ⑮ | 32057508040000 | " ,Right | " | -do.- | | |
| ⑯ | 32057508609220 | " ,Left | " | NS-1000MS | | |
| ⑰ | 32057508609221 | " ,Right | " | -do.- | | |
| ⑱ | 420000ER235200 | Flat Head Screw 3.5 x 20 (ZMC2 - BL) | 丸皿木ネジ | NS-1000, 1000M, 1000MS (Net Work) | | |
| ⑲ | 420000ER231160 | -do.- 3.1 x 16 (-do.-) | " | -do.- (Level Control) | | |
| ㉑ | 420000EZ000170 | SEMS Screw M4 x 30 (FNM3 x 3g) | ナベ小ネジ | -do.- (Tweeter & Squaker) | | |
| ㉒ | 420000EZ000300 | -do.- M6 x 30 (-do.-) | " | -do.- (Woofers) | | |
| ㉓ | 420000EP341400 | Flat Head Screw 4.1 x 40 (ZMC - BL) | 鉄皿木ネジ | -do.- (Back Board) | | |